

### ATLANTIS RAIL Contact Information:

Atlantis Rail Systems

70 Armstrong Road  
Plymouth, MA 02360

3900 Civic Center Drive

North Las Vegas, NV 89030

(800) 541-6829 or (508) 732-9191

(508) 732-9798

www.atlantisrail.com

### HandiSwage<sup>™</sup> Cable Railing Installation Instructions

Atlantis Rail's HandiSwage Cable Railing System is an easy to use cable railing product utilizing fittings that are an adaptation of traditional swage fittings. They can be attached to cable using Atlantis Rail's hand swage tool. HandiSwage combines the aesthetic appeal, quality and durability of RailEasy<sup>™</sup> cable railing with the convenience and economy of 1/8" cable. The following guide will take you step-by-step through the process of installing your HandiSwage cable system, offering helpful tips and tricks along the way.

### Table of Contents

Tools	1
Tips for a Successful Installation	1
HandiSwage Components	2
Straight Section - Preparation	3
Straight Section - Installing the Cable	4
Straight Section - Tensioning the Cable	5
Straight Section - Install Cover Nuts	7
Stairs & Ramp Section - Preparation	7
Stairs & Ramp Section - Installing the Cable	9
Stairs & Ramp Section - Tensioning the Cable	10
Stairs & Ramp Section - Install Cover Nuts	12
Additional Components	12
HandiSwage Cable Railing System Specifications	14
HandiSwage Cable Railing Specifications Part Numbers and Descriptions	15



### Tools

#### Required & Recommended



### Tips for a Successful Installation

- Read the instructions completely before beginning the installation.
- Plan your railing project. Sketch your project with the actual measurements of your deck or balcony complete with post locations.
- Check carton(s) to determine part count is complete.
- Installation is best accomplished with two (2) people.
- Always wear personal protection equipment; safety glasses, work gloves, etc.



**ALWAYS USE WORK GLOVES AND WEAR SAFETY GLASSES TO PROTECT YOUR HANDS AND EYES WHILE WORKING WITH CABLE.**



**ATLANTIS RAIL SYSTEMS PROVIDES A VARIETY OF MOUNTING OPTIONS FOR POSTS AND RAILS USED IN OUR SYSTEMS. PRODUCTS OF THIS NATURE REQUIRE THAT MOUNTING SURFACES ARE CONSTRUCTED TO BE CONSIDERED STRUCTURAL PER BUILDING CODE DEFINITION FOR THE SURFACE MATERIAL USED. STRUCTURAL INTEGRITY AND BUILDING CODE COMPLIANCE OF MOUNTING SURFACES ARE THE RESPONSIBILITY OF THE END USER AND / OR INSTALLER. THE USE OF ANY OF OUR MOUNTING METHODS ARE AT THE OPTION AND DECISION OF THE END USER AND / OR INSTALLER AND SHOULD BE SELECTED TO MATCH THE STRUCTURAL MATERIAL USED TO CREATE THE MOUNTING SURFACE.**



**ALWAYS REFER TO YOUR LOCAL BUILDING CODE OFFICIALS PRIOR TO INSTALLING ANY ATLANTIS RAIL SYSTEM TO ENSURE ALL CODE AND SAFETY REQUIREMENTS ARE MET. ATLANTIS RAIL SYSTEMS IS NOT RESPONSIBLE FOR IMPROPER OR NON-RECOMMENDED INSTALLATIONS.**

## HandiSwage™ Components

	C0731-H0703-2	HandiSwage™ Standard Stud 1/8" (1/4"-28 RH) - 2 Pack
	C0731-H0703-10	HandiSwage™ Standard Stud 1/8" (1/4"-28 RH) - 10 Pack
	C0731-HL703-2	HandiSwage™ Long Stud 1/8" (1/4"-28 RH) - 2 Pack
	C0731-HR03-2	HandiSwage™ Lag Stud 1/8"
	C0748-0003-2	HandiSwage™ Tensioner 1/8" - 2 Pack
	C0981-P003-2	HandiSwage™ Flush Fitting 1/8" - 2 Pack

## Additional Components



Acorn Nut Set



Deluxe Cover Nut Set



HandiSwage™  
Cover Nut Sets

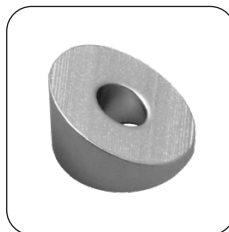

30°, 34° & 38°  
Stair Spacer



HandiSwage™  
Cable Sleeve

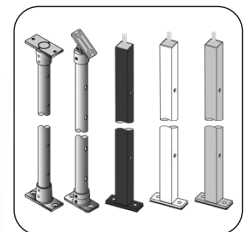

Cable Stabilizer Kits

## Straight Section - Preparation

The infill for Atlantis Rail's HandiSwage System is comprised of cable and a variety of fittings. The following section will show you how to install fittings on straight sections.

### HandiSwage Studs (C0731 Series)

#### Measure & Mark Your Posts

Determine the number of cable runs you will need to maintain code compliance. We offer a handy drilling template that is spaced at 3" to help you locate your centers.

Atlantis Rail offers a drilling template (part # C0988-1000) to aid in your installation process. Ask your Sales Representative for more information.



Find the center of the post face and draw a vertical line. Measure your spacing up from the mounting surface or top of your bottom rail to the underside of the top rail. Using a carpenter's square, draw lines across the post face making sure they intersect with the center line you just drew (See Figures A & B). Repeat for both sides on every post.



**ATLANTIS RAIL REQUIRES SPACING YOUR CABLE AT 3" ON CENTER TO HELP AVOID ANY POTENTIAL BUILDING INSPECTION OR SAFETY ISSUES.**

For corners you must offset your holes by 1/2" to avoid having the HandiSwage studs interfere with each other or cause a weakened post situation or double post (See Figure C).

#### Drill Your Posts

Using a 9/32" drill bit, drill straight through the end and corner posts. Drilling the posts from each side and attempting to meet them in the middle will help you hit your centers more accurately and will make for a neater installation. Be sure your drill is level and that the hole goes all the way through the post. The swage terminal should be able to pass completely through this hole.

### Flush Fitting (C0981-P003-2)

The flush fitting is designed to ease installation by eliminating the need for accurate measurement and swaging at one end of a cable run. You still use a HandiSwage terminal on the other end of the cable run. When using the flush fitting on one end you will re-drill the back end of the post (See Figure D) with a 3/8" bit approximately 1-1/4" deep to accept the flush fitting. See additional instructions on page 4 for running cable using the flush fitting. Cover nut sets are sold separately.

### Lag Stud (C0731-HR Series)

The lag stud is designed for use in short runs and must always be used with a tensioning device at the opposite end of the cable run. With a 3/16" drill bit, drill approximately 1-5/8" deep to accept the lag stud (See Figure E). Using a 5/32" wrench, turn the lag stud until it is fully seated to the face of the post.

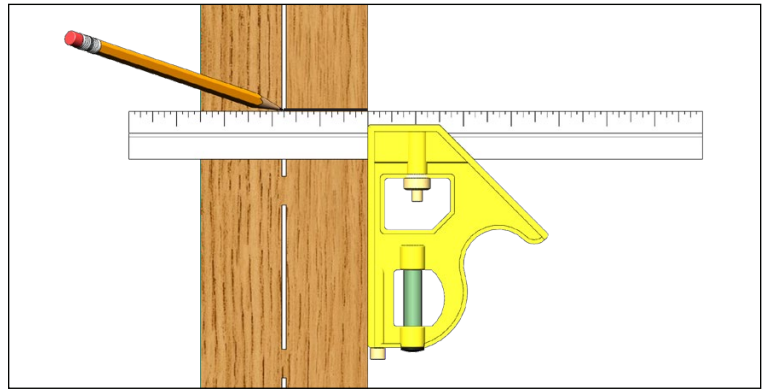

Figure A. Measure and mark both sides of every post at 3" on center.

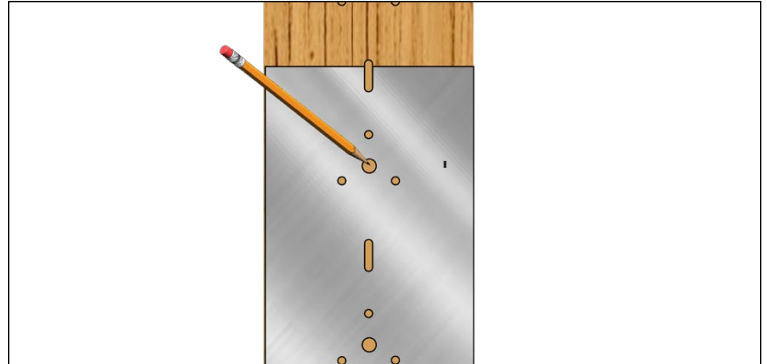

Figure B. Atlantis offers a drilling template to help you find your centers.

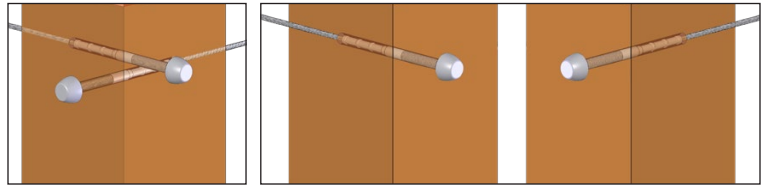

Figure C. (LEFT) For corners, offset your holes by 1/2" to avoid stud interference and/or weakening of posts or (RIGHT) double post.

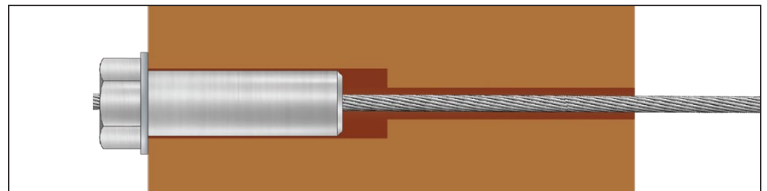

Figure D. Re-drill the back end of the post with a 3/8" bit to accept the flush fitting.

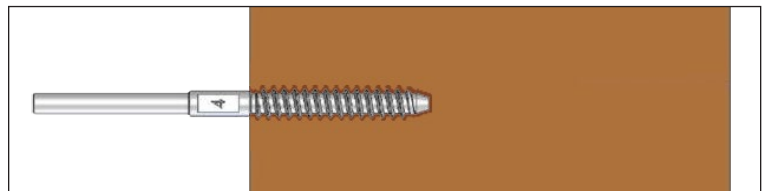

Figure E. With a 3/16" drill bit, drill approximately 1-5/8" deep to accept the lag stud. Use a 5/32" open wrench on the flats of the stud to install into a wood post.

## Stabilizer Kits (A0908 Series, S0950 Series)

More information is available in the Additional Components section found towards the end of these installation instructions. Refer to the Cable Stabilizer Kit installation instructions for detailed information on how to properly install cable stabilizers.

## Cable Sleeve (C0915-0338 or C0915-0338-F)

More information is available in the Additional Components section found towards the end of these installation instructions. Refer to the Cable Sleeve installation instructions for detailed information on how to properly install cable sleeves.

## Straight Section - Installing the Cable

The infill for Atlantis Rail's HandiSwage System is comprised of cable and a variety of fittings. The following section will show you how to install cable on straight sections.

### HandiSwage Studs (C0731 Series)

#### Measure & Run the Cable

HandiSwage has the advantage of hidden tensioning as shown in Figures G through H. Since the tensioning threads are concealed by the post you can usually pre-cut all cables. On standard 4" x 4" posts, you can simply measure from "outside to outside" of your cable run post (See Figure F) and subtract 2-3/4" to determine your proper cable length. This will leave approximately 1-5/8" tensioning thread at both ends. Make sure measurements are always from the outside of the post to outside of the opposite post. Beginning at the top, attach the cable to the swage terminal in accordance with the hand swaging tool instructions. It is important to follow the accompanied instructions.

If you're using the HandiSwage Cover Nut Set, place the washer, nut and lock nut on the end of the shank. Set aside the cover for tensioning later (See Figure G). On the other end of the cable run, place another swage fitting against the post. Thread the washer and nut onto the end. Leave the tensioning nut as much travel as possible. Pull the cable tight by hand to the back of the swage fitting. Mark and cut the cable (See Figure H).

Feed the cable through all the mid posts. Follow the swaging instructions again and swage the second fitting onto the cable. Re-attach the washer and nut. Repeat the above steps until all the cables are run before applying tension.

### Flush Fitting (C0981-P003-2)

If using the HandiSwage Flush Fitting measure the entire span from outside to outside cable run posts and add 2 inches beyond the post at the opposite end and cut your cable to that length. Re-drill the back end of the post with a 3/8" bit approximately 1-1/4" deep to accept the flush fitting (See Figure I). Run your cable to the opposite post where you have drilled the post to accept the flush fitting, going through all mid posts. At the opposite end, put the cable through the end post and through the flush fitting. Attach the flush fitting to the cable in a pushing and twisting motion (See Figure J).

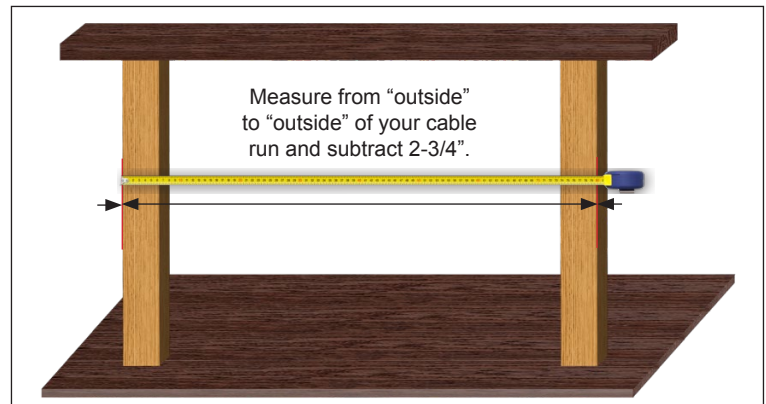

**Figure F.** On standard 4" x 4" posts you can simply measure from "outside to outside" of your cable run post.

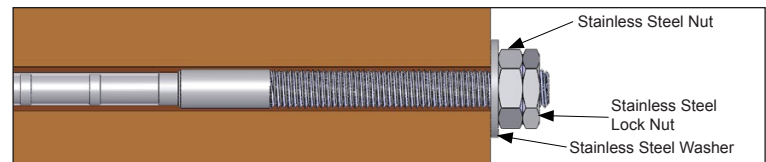

**Figure G.** Attach the first cable to the swage terminal. Place the washer, nut and lock nut on the end of the shank and pull the cable tight.

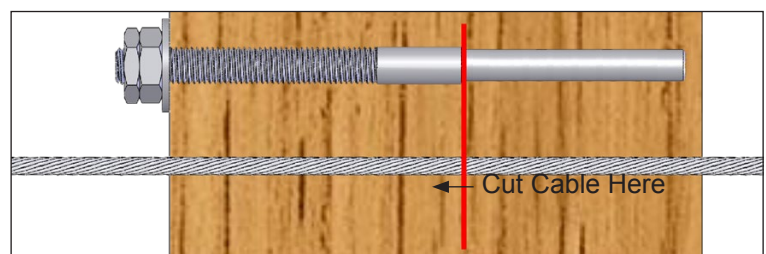

**Figure H.** Pull the cable tight by hand to the back of the swage fitting. Using the outside of the post as a guide, mark and cut the cable.

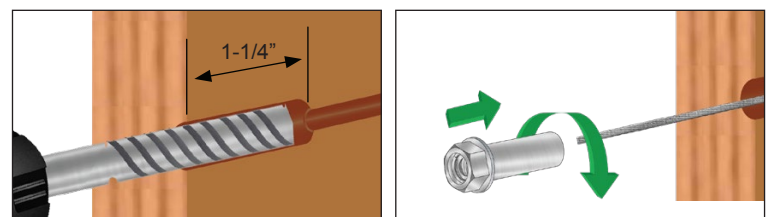

**Figure I. (Left)** Re-drill the back end of the post with a 3/8" bit approximately 1-1/4" deep to accept the flush fitting.

**Figure J. (Right)** Attach the flush fitting to the cable in a pushing and twisting motion.



**MAKE SURE CABLE IS CUT SQUARE TO AVOID FRAYING.**

Tension the cable at the opposite post before cutting the cable flush using a hacksaw or cutting disc, cut the cable straight and even against the fitting (See Figure K). Using a rubber mallet, lightly tap on the desired cover nut sets until flush with the post. Cover nut sets are sold separately (See Figure L).

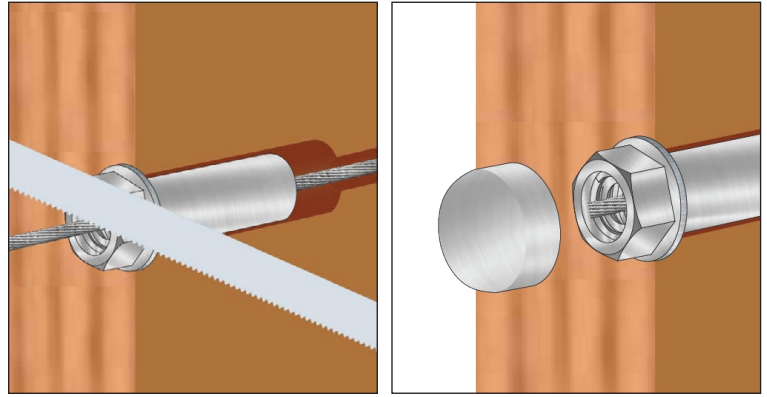
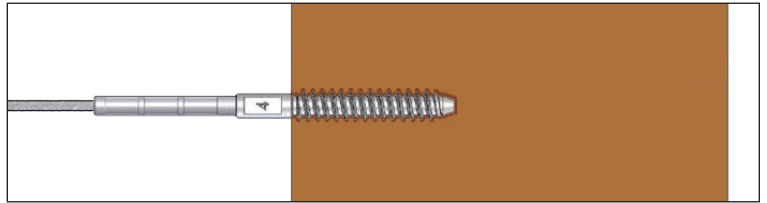

**Figure K. (Left)** Tension the cable at the opposite post before cutting the cable flush using a hacksaw or cutting disc, cut the cable straight and even against the fitting.

**Figure L. (Right)** Using a rubber mallet, lightly tap on the desired cover nut sets until flush with the post. Cover nut sets are sold separately.

### Lag Stud (C0731-HR Series)

Crimp the cable in accordance with the swaging tool instructions. Pull the cable the length of its run and cut it a little long. You will need to cut it to length later. When the lag stud is installed (See Figure M), finish running the cable using the method prescribed above. The lag stud must have a tensioning device on the other end of the cable run.



**Figure M.** Completed Lag Stud Assembly.

## Straight Section - Tensioning the Cable



**BEFORE TENSIONING ANY OF THE CABLES, IT IS IMPORTANT TO BE SURE THAT THE FRAME FOR THE INFILL IS COMPLETED.**

Make sure the posts are installed securely and in accordance with the manufacturers' recommended installation procedures. Install all top and intermediate rails. The posts will deflect beyond allowable limits if you attempt to tension the cables on an incomplete guard frame. Before tensioning with tools, hold the stud fittings firm and tension the nuts of the system by hand until all cables are snug.



**ATLANTIS RAIL RECOMMENDS USING LOCTITE THREAD-LOCKER BLUE 242 ON THE THREADS OF THE HANDISWAGE STUD. APPLY A DROP TO THE THREADS AS CLOSE TO WHERE THE NUT WILL BE TIGHTENING AGAINST THE WASHER AS POSSIBLE. USE A DAMP CLOTH TO CLEAN UP EXCESS RESIDUE IMMEDIATELY.**



## HandiSwage Studs (C0731 Series)

### General Cable Tensioning

When tensioning cable using a HandiSwage stud, you must hold the stud or cable in a neutral position while turning the nut to apply tension. There are two methods to accomplish this; both requiring a pair of vice grip pliers.

- 1) You can hold the back of the swage stud with the vice grips which requires at least 1/4" space between the tensioning nut and the end of the stud (See Figure N).
- 2) You can use a Cable Grip Pad to hold the cable just outside the post while you tension the stud using the tensioning nut (See Figure O).



**USING METHOD 2 REQUIRES A HANDISWAGE CABLE GRIP PAD. NEVER CLAMP PLIERS OR VICE GRIPS DIRECTLY ON CABLE. SET YOUR VICE GRIPS WITH 1/8" SPACE TOTAL BETWEEN CABLE AND VICE GRIP JAWS. PLACE PAD ON CABLE AND THEN APPLY THE VICE ACTION TO THE PLIERS.**

Atlantis Rail offers a Cable Grip Pad (part # E0114-0000) to aid in your installation process. Ask your Sales Representative for more information.

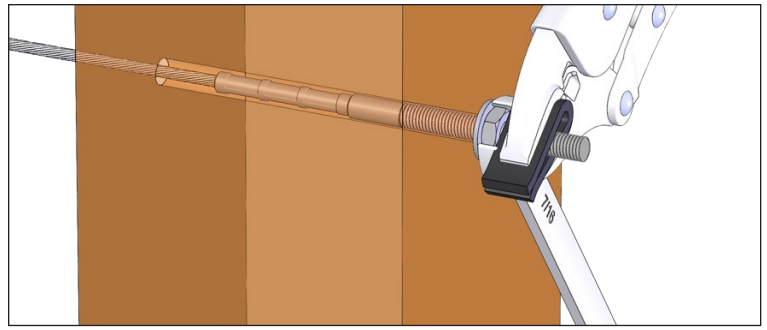
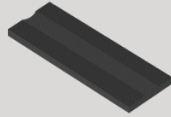

**Figure N. (METHOD 1)** Hold the back of the swage stud with vice grips while tightening the tension nut.

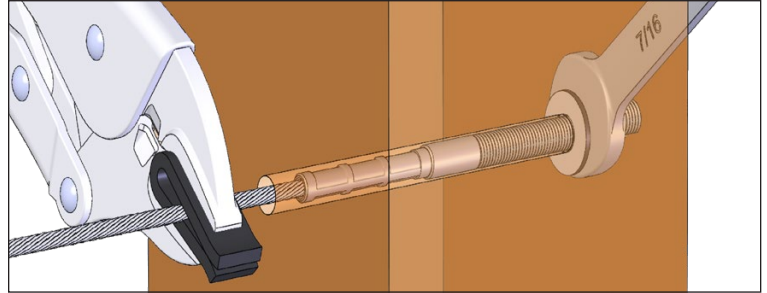

**Figure O. (METHOD 2)** Using a HandiSwage™ Cable Grip Pad and vice grips, hold the cable in a fixed position while tightening the tension nut.

### Tension the Center Cable

Beginning with the center run of cable, hold the swage terminal firm using one of the methods described above and tighten the tensioning nut with a 7/16" wrench. Tighten the nut three or four full rotations until cable is snug. Don't worry if this cable moves a little, we will come back around to it later.

### Tension the Remaining Cables

Alternate tensioning the cables from the center, working above and below the center cable as if tightening the lug nuts on a tire (See Figure P). Again tension the nuts three or four full rotations or until cable is snug. You will notice as you tension, the cables surrounding it will slacken. When this happens, stop tensioning and move onto the next cable.

### Make Final Adjustments

Go back to the center cable and re-tighten the cables until all are tight and relatively equal in tension. You may find that you need to do this three or four times getting down to even a quarter turn of the tensioning nut each time. Tension from both sides when necessary.

### Flush Fitting (C0981-P003-2)

If using a flush fitting, the opposite end of the cable assembly requires a HandiSwage tensioning device. The Flush Fitting should be installed in the post and have cable installed in it. Follow the tensioning directions for HandiSwage studs to tension the other side of the Flush Fitting cable run.

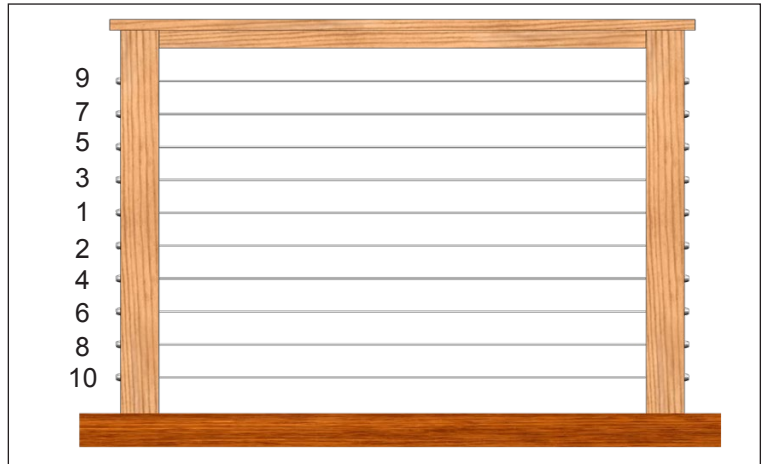

**Figure P.** Tensioning Diagram - Begin with the center run of cable and alternate working above and below until cables are tight.

## Lag Stud (C0731-HR Series)

If using a Lag Stud, the opposite end of the cable assembly requires a HandiSwage tensioning device. The Lag Stud should be installed in the post and have the cable installed in it. Follow the tensioning directions for HandiSwage studs to tension the other end of the Lag Stud cable run.

## Straight Section - Installing Cover Nuts

### HandiSwage Cover Nut Sets (C0309 Series)

HandiSwage Cover Nut Sets (See Figure Q) are designed for use with HandiSwage Studs and are perfect for cable railing systems where “through-post” hardware is desired for minimal obstruction). Affix to end of swage stud for the finished look. The HandiSwage Cover Nut Sets comes with a stainless steel nut and washer in packs of 10 and are available in the following colors: white, light brown, dark brown, metallic silver and black.

- 1) With the cables tensioned, it's time to install the lock nuts and cover nuts. This is accomplished in just three easy steps, and you just did one of them! Using the HandiSwage Combination Wrench (part # C0731-TK01-2) hold in place the nut with the 7/16" end of the wrench and tighten the lock nut with the 3/8" end of the wrench.
- 2) Using a hacksaw, cut the remaining shank off flush with the lock nut.
- 3) Then place the cover nut over the assembly until it is flush with the post (See Figure R).

In addition to the HandiSwage Cover Nut Sets Atlantis Rail offers an Acorn Nut Set (part # C0308-UF07-2) and Deluxe Cover Nut Set (part # C0307-U007-2). More information is available in the Additional Components section found towards the end of these installation instructions.



Figure Q HandiSwage™ Cover Nut Sets.

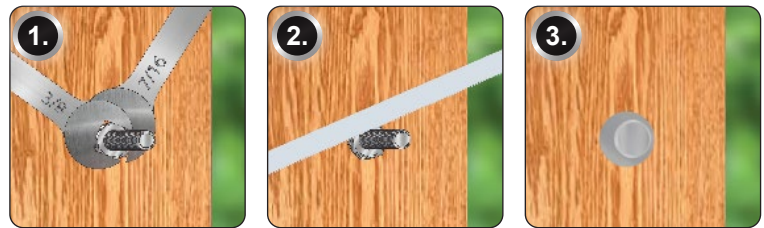

Figure R. The HandiSwage™ Cover Nut Set installs in just 3 easy steps: tighten, cut and cover.

## Stair & Ramp Section - Preparation

### Measure and Mark your Posts

As in the previous section, begin by determining the number of cables you need to maintain code compliance.



**ATLANTIS RAIL REQUIRES SPACING YOUR CABLE AT 3" ON CENTER TO HELP AVOID ANY POTENTIAL BUILDING INSPECTION OR SAFETY ISSUES.**

As before, find the center of your posts and draw a vertical line. Snap a chalk line parallel to the slope of the stairs at the height of your lowest cable run. Measure for your other cables 3" on center perpendicular to that line (See Figure S). Snap a chalk line for each cable run.

Using a carpenter's square, transfer a line to the inside post face to find the center of your cable (See Figure T). Where this line intersects the vertical line is the center point for your cable.

### Use Your Fittings as a Guide

On the end posts, place the center of your fittings on the marks made in the previous section. Carefully mark and pre-drill the centers of the fasteners using a 1/8" drill bit.

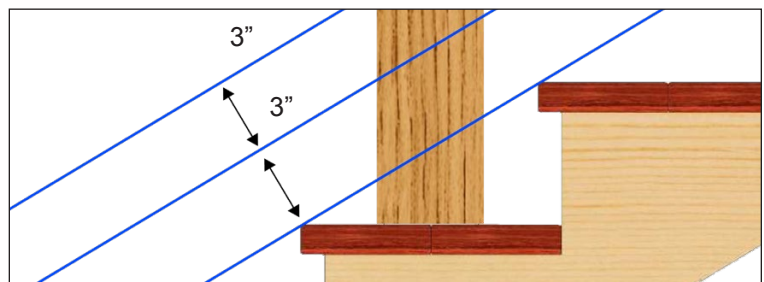

Figure S. Measure perpendicularly from the chalk line to find the center line of your cables.

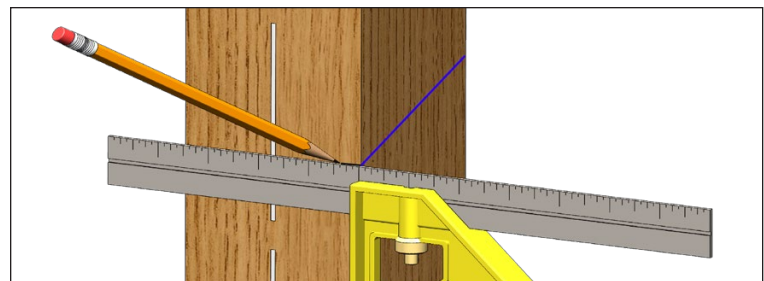

Figure T. Using a carpenter's square, transfer the chalk line to the inside face of the post. The intersection of this line and the vertical will mark your center.

The HandiSwage Tensioner base uses three (3) #8 screws. When installing tensioners on stairs make sure the notch is facing vertical allowing the 45° of motion up or down. As an additional component Atlantis Rail offers a drilling template that has hole patterns laid out for ease of use. See below for more information.

**Additional Components:** Atlantis Rail offers a drilling template (part # C0988-1000) to help with the installation of the HandiSwage Tensioner. It has the circular hole pattern of the HandiSwage Tensioner base spaced conveniently at three inches on center to make laying out your cable easy.



## HandiSwage Studs (C0731 Series)

A HandiSwage Stud or Long Stud can be used in place of the tensioner (part # C0731-H0703-2 or C0731-HL03-2).

### Drill the Mid Posts

Find your hole locations using the method described above. Carefully drill the mid posts using a 3/16" drill bit. Use a spotter on the side to make sure that the drill is angled properly. It is important to drill the angle correctly to prevent the cable from bending or kinking. There are several drill guide tools commercially available to help you with this task.

### 34 Degree Stair Spacer - C0841-0034-2

When installing cable infill on stair posts, a 34° Stair Spacer (part # C0841-0034-2) is used to achieve the angled cable run. Place the stair spacer on the threaded end of the stud before attaching the desired cover nut set (See *Figure U*).



30° (part # C0841-0030-2) & 38° (C0841-0038-2)  
STAIR SPACERS ARE ALSO AVAILABLE.

Using a HandiSwage Stud (part # C0731-H0703 -2) or a HandiSwage Long Stud (part # C0731-HL703 -2) on a stair rail paired with stair spacers allows the use of a desired cover nut set.

## HandiSwage Tensioner (C0748-0003-2)

### Drill the Stair Posts

Use the HandiSwage Tensioner (part # C0748-0003-2) for attaching runs of cable to the NOVA II stair sections.

The HandiSwage Tensioner is comprised of a number of components to keep your cable railing system properly tensioned (See *Figure V*).

**Use only 1/8" stainless steel cable with the HandiSwage tensioner.**

Pre-drill the holes on the top and bottom stair posts using a 9/64" drill bit. Fasten the HandiSwage Tensioners using three (3) #8 x 1-1/2" screws (supplied).

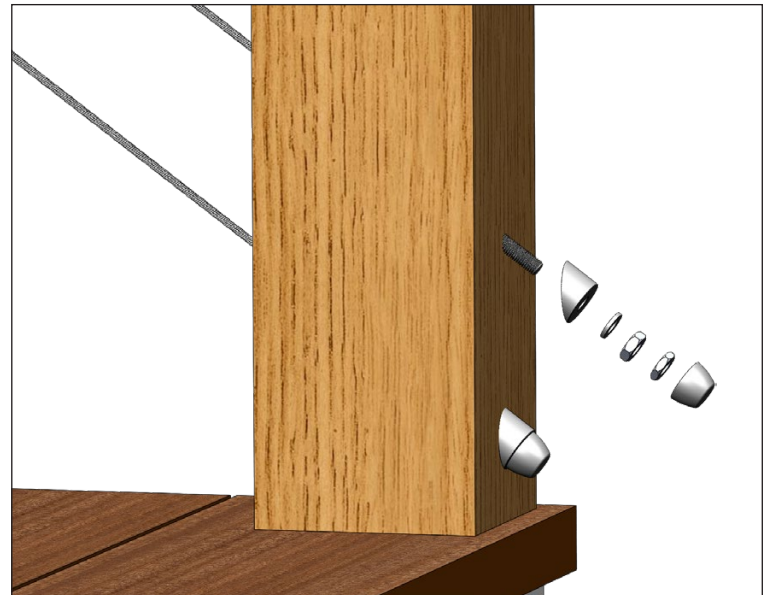

**Figure U.** Place the 34 Degree Stair Spacer on the threaded end before attaching the cover nut set to achieve the angled cable run.

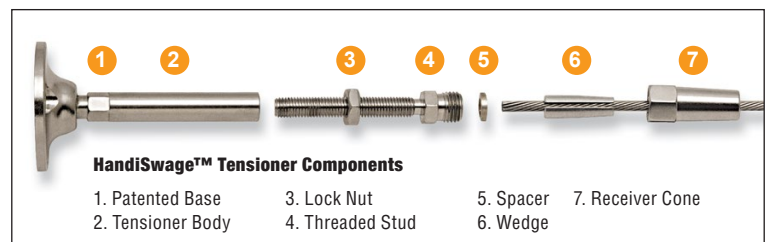

**Figure V.** HandiSwage™ Tensioner components and HandiSwage™ Single Mount Tensioner components.

## Stair & Ramp Section - Installing the Cable

### HandiSwage Tensioner (C0748-0003-2)

#### Measure & Run the Cable

- 1) Extend Threaded Stud 3/4" for a section of 20 feet or less and extend an additional 1/4" for every 10 feet thereafter (See Figure W). Maximum recommended cable span is 48'.
- 2) Insert cable into Receiver Cone, Wedge and Spacer until it is fully seated in the Threaded Stud.
- 3) Thread Cone Assembly onto the Threaded Stud using 7/16" and 3/8" open wrenches. Tighten until threads are no longer visible (if possible) and Receiver Cone is tight.

**For additional instructions refer to the RailEasy Tensioner installation instructions.**

Atlantis Rail offers installation tools (part # C0988-0000) to aid in your installation process. Ask your Sales Representative for more information.

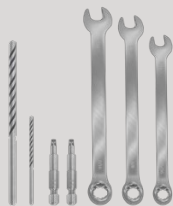

**THE HANDISWAGE TENSIONER WILL SWIVEL UP TO 45°. BY TURNING THE TENSIONER BASE UPSIDE DOWN SO THAT THE RECESS IS FACING UP, YOU CAN ANGLE THE TENSIONER UPWARD. SIMILARLY, TURN IT TO THE SIDE TO RUN CABLE ON A LATERAL ANGLE FOR CURVED OR ANGLED DECKS.**

The infill for Atlantis Rail's HandiSwage System is comprised of cable and a variety of fittings. The following section will show you how to install cable on stair sections.

### HandiSwage Studs (C0731 Series)

#### Measure & Run the Cable

HandiSwage has the advantage of hidden tensioning as shown in Figures X and Y. Since the tensioning threads are concealed by the post you should leave approximately 1-5/8" tensioning thread at both ends. Beginning at the top, attach the cable to the swage terminal in accordance with the hand swaging tool instructions. It is important to follow the accompanied instructions.

If you're using the HandiSwage Cover Nut Set, place the Stair Spacer, washer and nut on the end of the shank. Set aside the cover for tensioning later (See Figure X). On the other end of the cable run, place another swage fitting against the post. Pull the cable tight by hand to the back of the swage fitting. Mark and cut the cable.

Feed the cable through all the mid posts. Follow the swaging instructions again and swage the second fitting onto the cable.

Re-attach the washer and nut. Repeat the above steps until all the cables are run before applying tension.

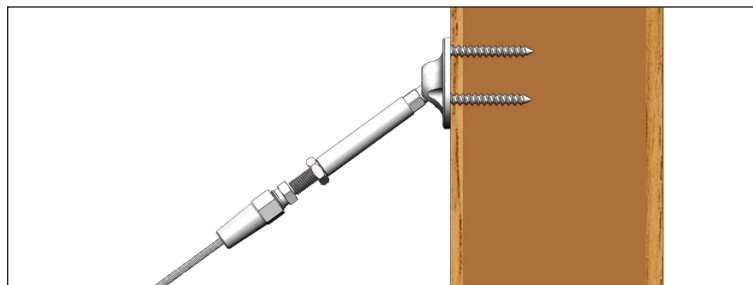

**Figure W.** Extend the stud leaving 3/4" of thread for 20' or less. For every additional 10', leave another 1/4" of thread exposed.

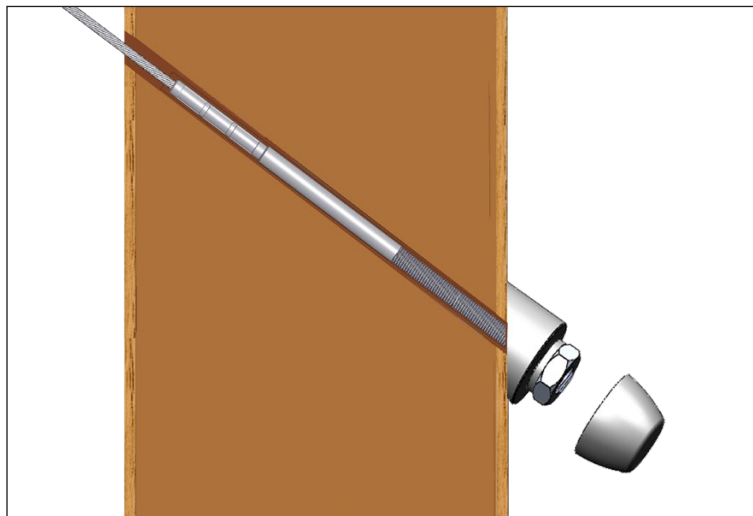

**Figure X.** Attach the first cable to the swage terminal. Place the Stair Spacer, washer and nut on the end of the shank and pull the cable tight.

### 34 Degree Stair Spacer - C0841-0034-2

When installing cable infill on stair posts, a 34° Stair Spacer (part # C0841-0034-2) is used to achieve the angled cable run. Place the stair spacer on the threaded end of the stud before attaching the desired cover nut set (See *Figure Y*).



30° (C0841-0030-2) & 38° (C0841-0038-2) stair spacers are also available.

Using a HandiSwage Stud (part # C0731-H0703 -2) or a HandiSwage Long Stud (part # C0731-HL703 -2) on a stair rail paired with stair spacers allows the use of a desired cover nut set.

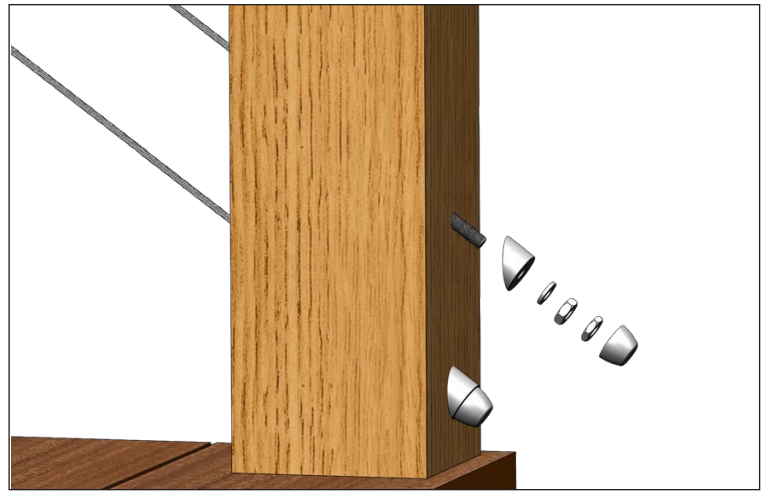

**Figure Y.** Place the 34 Degree Stair Spacer on the threaded end before attaching the cover nut set to achieve the angled cable run.

## Stair & Ramp Section - Tensioning the Cable

Before tensioning any of the cables, it is important to be sure that the frame for the infill is completed. Make sure the posts are installed securely and in accordance with the manufacturers' recommended installation procedures. Install all top and intermediate rails. The posts will deflect beyond allowable limits if you attempt to tension the cables on an incomplete guard frame.

### HandiSwage Tensioner (C0748-0003-2)

(See *Figure Z*)

#### Tension the Center Cable

Before tensioning with tools, hold the stud fitting firm and rotate the tensioner body by hand until all cables are snug. Beginning with the center run of cable, hold the tensioner terminal still using a 3/8" wrench. Using a 5/16" open wrench, rotate the tensioner body to tension the cable (See *Figure AA*). Turn the body three or four full rotations until cable is snug. Don't worry if this cable moves a little, we will come back around to it later.

Hold hex flats on Threaded Stud with a wrench. Place a wrench on hex flats of Tensioner Body and rotate Tensioner Body as needed. Tension cable equally from both ends of each cable span. Tighten Lock Nut to secure tension. Add "Non-Acidic" Silicone Sealant to open tip of Receiver Cone in harsh environments. For additional instructions refer to the RailEasy Tensioner installation instructions.



**ALWAYS USE WORK GLOVES AND WEAR SAFETY GLASSES TO PROTECT YOUR HANDS AND EYES WHILE WORKING WITH CABLE. DO NOT OVER-TENSION.**

#### Tension the Remaining Cables

Alternate tensioning the cables from center, working above and below the center cable as if tightening the lug nuts on

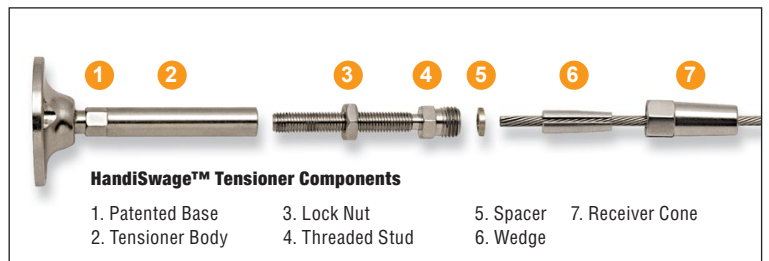

**Figure Z.** HandiSwage™ Tensioner components.

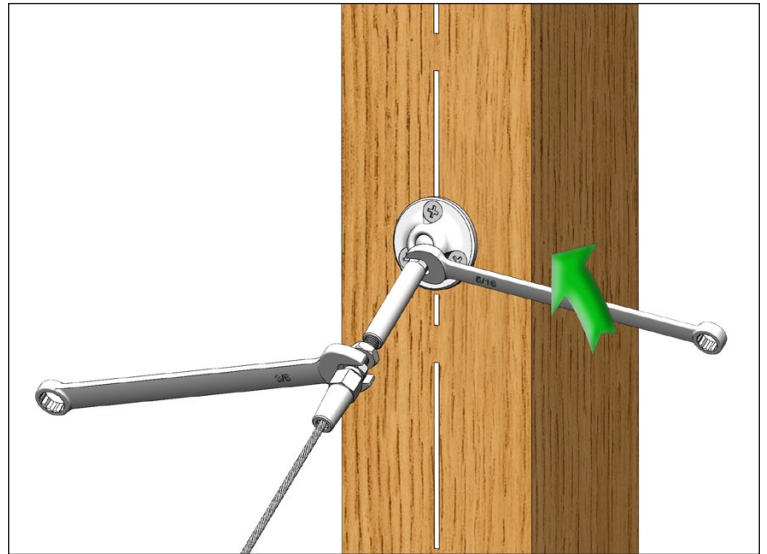

**Figure AA.** Hold the tensioner terminal still with a 3/8" wrench and using a 5/16" open wrench, rotate tensioner body to tension.

### Tension the Remaining Cables

Alternate tensioning the cables from center, working above and below the center cable as if tightening the lug nuts on a tire (See *Figure AB*). Rotate the body three or four full rotations or until cable is snug. You will notice as you tension, the cables surrounding it will slacken. When this begins happening, stop tensioning and move onto the next cable.

### Make Final Adjustments

Go back to the center cable and re-tighten the cables until all are tight and relatively equal in tension. You may find that you need to do this three or four times getting down to even a quarter turn of the tensioner body each time. Tension from both sides when necessary.

## HandiSwage Studs (C0731 Series)

### General Cable Tensioning

When tensioning cable using a stud of any type, you must hold the stud or cable in a neutral position while turning the nut to apply tension. There are two methods to accomplish this; both requiring a pair of vice grip pliers.

- 1) You can hold the back of the swage stud with the vice grips which requires at least 1/4" space between the tensioning nut and the end of the stud (See *Figure AC*).
- 2) You can use a Cable Grip Pad to hold the cable just outside the post while you tension the stud using the tensioning nut (See *Figure AD*).



**USING METHOD 2 REQUIRES A HANDISWAGE CABLE GRIP PAD. NEVER CLAMP PLIERS OR VICE GRIPS DIRECTLY ON CABLE. SET YOUR VICE GRIPS WITH 1/8" SPACE TOTAL BETWEEN CABLE AND VICE GRIP JAWS. PLACE PAD ON CABLE AND THEN APPLY THE VICE ACTION TO THE PLIERS.**

Atlantis Rail offers a Cable Grip Pad (part # E0114-0000) to aid in your installation process. Ask your Sales Representative for more information.

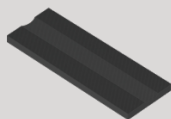

### Tension the Center Cable

Beginning with the center run of cable, hold the swage terminal firm using one of the methods described above and tighten the tensioning nut with a 7/16" wrench. Tighten the nut three or four full rotations until cable is snug. Don't worry if this cable moves a little, we will come back around to it later.

### Tension the Remaining Cables

Alternate tensioning the cables from the center, working above and below the center cable as if tightening the lug nuts on a

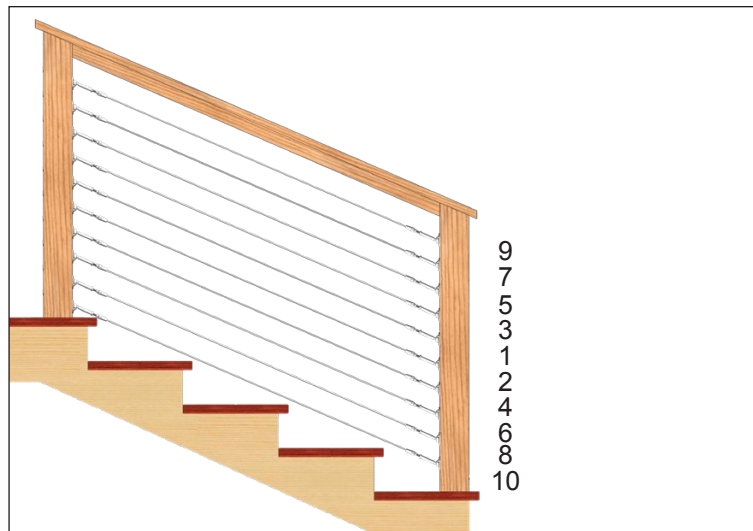

**Figure AB.** Tensioning Diagram - Begin with the center run of cable and alternate working above and below until cables are tight.

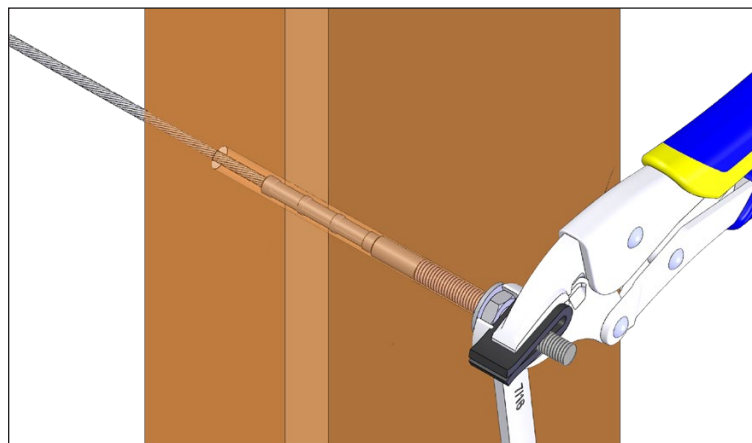

**Figure AC.** (METHOD 1) Hold the back of the swage stud with vice grips while tightening the tension nut.

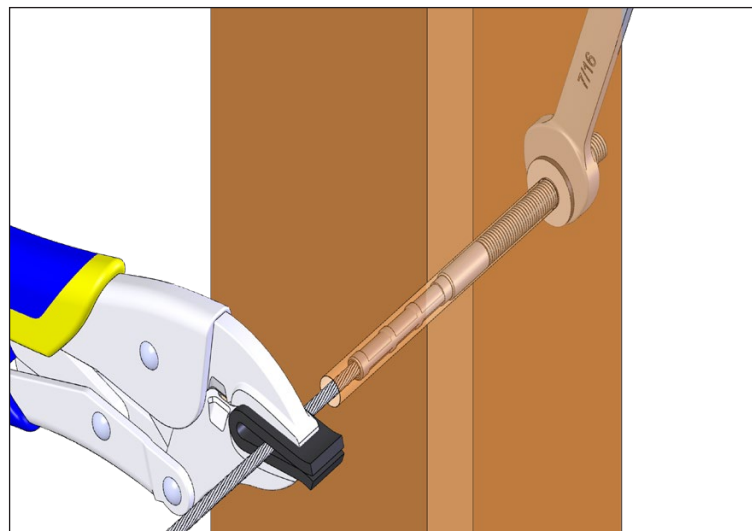
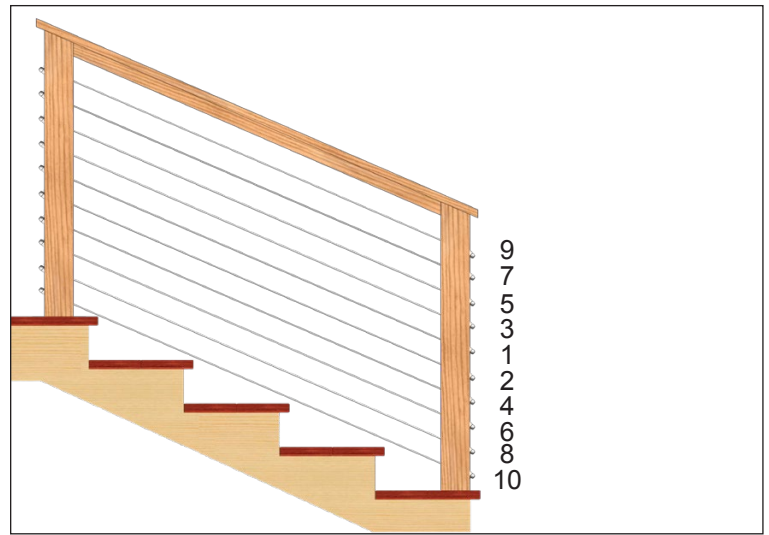

**Figure AD.** (METHOD 2) Using a HandiSwage™ Cable Grip Pad and vice grips, hold the cable in a fixed position while tightening the tension nut.

tire (See Figure AE). Again tension the nuts three or four full rotations or until cable is snug. You will notice as you tension, the cables surrounding it will slacken. When this happens, stop tensioning and move onto the next cable.

### Make Final Adjustments

Go back to the center cable and re-tighten the cables until all are tight and relatively equal in tension. You may find that you need to do this three or four times getting down to even a quarter turn of the tensioning nut each time. Tension from both sides when necessary.



**Figure AE.** Tensioning Diagram - Begin with the center run of cable and alternate working above and below until cables are tight.

## Stair & Ramp Section - Installing Cover Nut Sets

### HandiSwage Cover Nut Set (C0309 Series)

Refer to the Straight Section - Installing Cover Nut Sets on page 7. More information is available in the Additional Components section found in the next section of these installation instructions.

## Additional Components

### Acorn Nut Set



C0308-UF07-2

Designed for use with HandiSwage Studs. This set is perfect for cable railing systems where “through post” hardware is desired for minimal obstruction. Affix the stainless steel acorn nut set to the end of a swage stud for a finished look (See Figure AF). Finish: Polished Stainless Steel. Available in 2 packs.

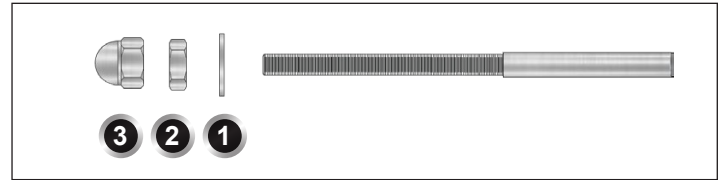

**Figure AF.** Acorn Nut Set Assembly Diagram - 1) Stainless Steel Washer, 2) Stainless Steel Nut & 3) Stainless Steel Acorn Nut. HandiSwage Stud not included.

### Deluxe Cover Nut Set



C0307-U007-2

Designed for use with the HandiSwage Studs. The Cover Nut Set is perfect for cable railing systems where “through-post” hardware is desired for minimal obstruction. Affix to the end of the stud for a finished look (See Figure AG). Finish: Polished Stainless Steel. Available in 2 packs.

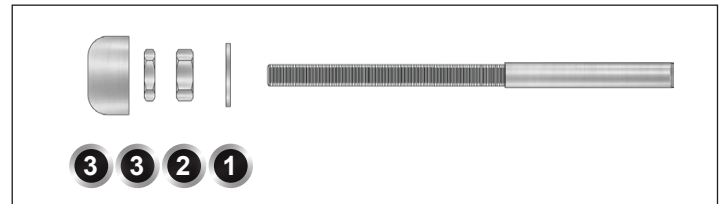

**Figure AG** Deluxe Cover Nut Set Assembly Diagram - 1) Stainless Steel Washer, 2) Stainless Steel Nut 3) Stainless Steel Lock Nut & 4) Stainless Steel Deluxe Cover. HandiSwage Stud not included.

## HandiSwage Cover Nut Set



C0309 Series

Designed for use with HandiSwage Studs. Cover Nut Sets are perfect for cable railing systems where “through-post” hardware is desired for minimal obstruction. Affix to end of swage stud for a finished look (See *Figure AH*). Finishes: White, Light Brown, Dark Brown, Metallic Silver and Black. Available in 10 packs.

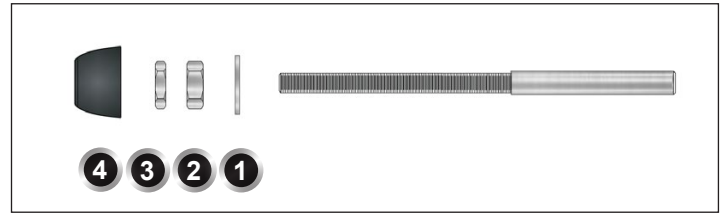

**Figure AH.** HandiSwage Nut Set Assembly Diagram - 1) Stainless Steel Washer, 2) Stainless Steel Nut 3) Stainless Steel Lock Nut & 4) HandiSwage Cover. HandiSwage Stud not included.

## Stair Spacer

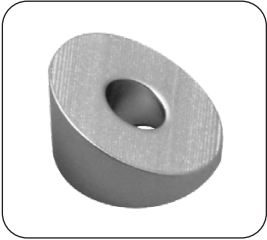

C0841 Series

The Stair Spacer is ideal for stair applications where a “through post” fitting is being utilized to achieve an angled cable run. It is available in 30, 34 and 38 degree angles. Install a cover nut set on the end for a finished look (See *Figure AI*). Available in 2 packs.

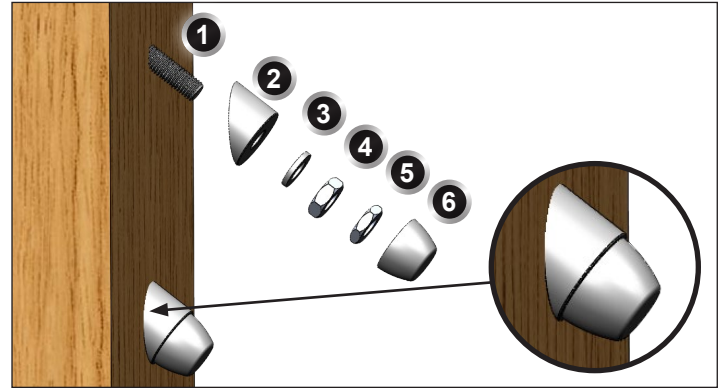

**Figure AI.** Stud, Stair Spacer & HandiSwage Cover Nut Set Assembly Diagram - 1) Stainless Steel HandiSwage Stud 2) Stainless Steel Spacer, 3) Stainless Steel Washer, 4) Stainless Steel Nut 5) Stainless Steel Lock Nut & 6) HandiSwage Cover. HandiSwage Stud & Cover Nut Set not included.

## HandiSwage Cable Sleeve

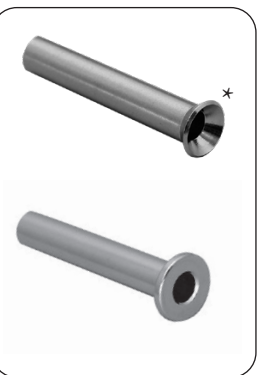

C0915-0338\* & C0915-0338-F

The HandiSwage Cable Sleeve is designed to protect your wood, vinyl or composite posts from chafing and incidental damage from cable rubbing around the outside of your mid post cable holes. It can also be used to accommodate angles up to 90 degrees (double posts required) and stairways coming off a straight run (See *Figures AJ and AK*). These sleeves are made from grade 316L stainless steel for corrosion resistance and durability.

For the mid posts, use a 7/32” drill bit and drill completely through the posts. Again, drilling from either side of the post and meeting in the middle will help you hit your centers and make for a neater installation. The cable will need to run through this hole without kinking or bending.

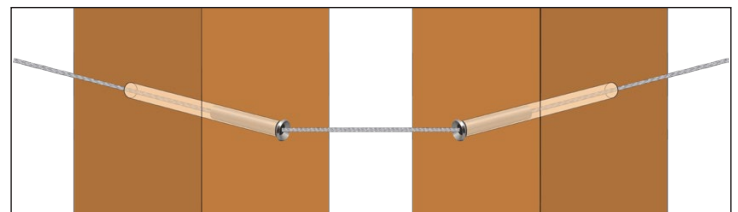

**Figure AJ.** Cable Sleeve Diagram - Accommodating angles up to 90 degrees. Doubling up on corner posts is required.

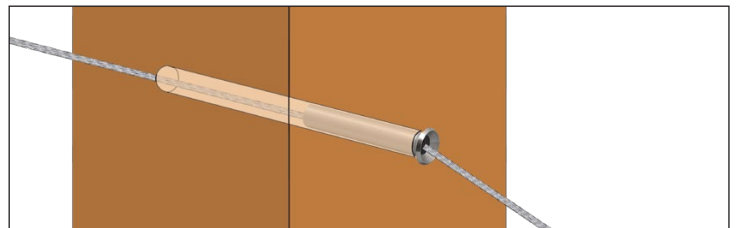

**Figure AK.** Cable Sleeve Diagram - Accommodating a stairway coming off a straight run.

\* Use the HandiSwage Cable Sleeve (part # C0915-0338) for wood posts (pictured). Use the HandiSwage Cable Sleeve Flush Mounted (part # C0915-0338-F) for vinyl and composite sleeves.

## Aluminum Cable Stabilizer Kit

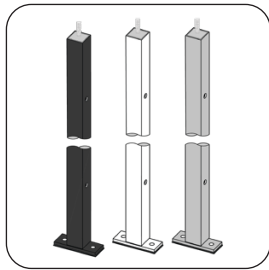

A0908 Series  
(Black, White and  
Metallic Silver)

This stabilizer kit is designed specifically for use where post to post measurement spans over 4 feet. Each kit comes with a 42" stanchion, mounting hardware, 3" hole spacing and fasteners. Cut at both ends for an accurate fit. This kit cannot be used to replace the use of a substantial mid post and should never be used in spans over 7'. Grommets are required for installation.

For detailed instructions refer to the Cable Stabilizer Installation Instructions.

## Cable Stabilizer Kit & Cable Stabilizer Stair Kit

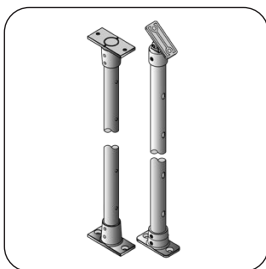

S0950 Series  
(316L Stainless Steel)

The Cable Stabilizer Kit and Stair Kit are designed specifically for use where post to post measurement spans over 4'. It enables you to adapt longer spans to code compliance by stabilizing the deflection of cable between posts. Each kit comes with a 42" stanchion pre-drilled to work with our standard 3" spacing. In most cases, stanchions must be field cut at both ends for an accurate fit. The Cable Stabilizer Kits cannot be used to replace the use of substantial mid posts and should never be used in spans over 7'. Kit includes fasteners.

For detailed instructions refer to the Cable Stabilizer Installation Instructions.

## HandiSwage Cable Railing System Specifications

The HandiSwage cable infill utilizes HandiSwage fittings with 1/8" cable. It is advised to observe that tension must be applied to fittings and cable. Posts should be mounted securely enough to resist detachment and hold under tension.

### Straight Sections

Atlantis Rail offers standard rail heights of 36" or 42" for straight sections.

### Stair Sections

Rail height for stair sections is available in 36" only.



**RAILING HEIGHTS ARE OFFERED IN THESE DIMENSIONS DUE TO NATIONWIDE BUILDING CODES. HOWEVER, ATLANTIS RAIL CAN SUPPLY CUSTOM HEIGHTS/LENGTHS UPON REQUEST.**

### Between Post Lengths

Atlantis Rail recommends staying within 4' section lengths to maintain structural integrity. If section lengths exceed 4', Atlantis Rail offers a Cable Stabilizer Kit to minimize cable deflection.

### Cable Spacing

The cable is spaced on posts at 3" on-center to comply with nationwide building codes.



**OTHER MATERIALS MAY BE USED BUT AT YOUR OWN DISCRETION.**

Atlantis Rail does not supply the guard frame for the HandiSwage Cable Railing System. Guard frame should be capable of receiving the mounting screws and withstanding deflection under tension. All components in the HandiSwage System are made of grade 316L stainless steel. Working load limit for all hand swage terminals is 60-70% of cable strength.

## HandiSwage™ System Product Specifications

Part Number	Description	Use
<b>Cable</b>		
S0701-0003-01	1/8" Cable, 100ft. Spool, 1x19, 316 Stainless Steel	Cable infill for HandiSwage Cable Railing
S0701-0003-02	1/8" Cable, 250ft. Spool, 1x19, 316 Stainless Steel	Cable infill for HandiSwage Cable Railing
<b>Hardware</b>		
C0731-H0703 -2	HandiSwage Standard Stud (2 Pack)	Swages onto end of cable to serve as a tensioning device
C0731-H0703 -10	HandiSwage Standard Stud (10 Pack)	Swages onto end of cable to serve as a tensioning device
C0731-HL703-2	HandiSwage Long Stud (2 Pack)	Swages onto end of cable for tensioning. Added length for versatility
S0731-HR03	HandiSwage Lag Stud	Use a termination fitting. Installs into wood and swages onto end of cable
C0731-HR03-2	HandiSwage Lag Stud	Use a termination fitting. Installs into wood and swages onto end of cable
C0748-0003-2	HandiSwage Tensioner (2 Pack)	Mechanically attaches to end of cable. Use as a surface mounted tensioner
C0748-H003-2	HandiSwage Tensioner w/ Stud (2 Pack)	Swages onto end of cable. Use as a surface mounted tensioner
C0981-P003-2	HandiSwage Flush Fitting (2 Pack)	Attaches to cable with self-locking mechanism. Use as a termination fitting
C0731-HG0703-2	HandiSwage Termination, Flat Head (2 Pack)	Swages onto end of cable. Use as a termination fitting
C0731-HG0703-10	HandiSwage Termination, Flat Head (10 Pack)	Swages onto end of cable. Use as a termination fitting
C0731-HS0703-2	HandiSwage Termination, Hex Head (2 Pack)	Swages onto end of cable. Use as a termination fitting
C0731-HS0703-10	HandiSwage Termination, Hex Head (10 Pack)	Swages onto end of cable. Use as a termination fitting
<b>Accessories</b>		
C0915-0338	HandiSwage Cable Sleeve (10 Pack)	Protects posts from cable. Ideal for wood post systems.
C0915-0338-F	HandiSwage Cable Sleeve, Flush (10 Pack)	Protects posts from cable. Ideal for vinyl or composite sleeved post systems
C0841-0022-2	Stair Spacer, 22 Degree (2 Pack)	Use with HandiSwage Studs to achieve angled cable runs on stairs
C0841-0030-2	Stair Spacer, 30 Degree (2 Pack)	Use with HandiSwage Studs to achieve angled cable runs on stairs
C0841-0034-2	Stair Spacer, 34 Degree (2 Pack)	Use with HandiSwage Studs to achieve angled cable runs on stairs
C0841-0038-2	Stair Spacer, 38 Degree (2 Pack)	Use with HandiSwage Studs to achieve angled cable runs on stairs
C0841-0041-2	Stair Spacer, 41 Degree (2 Pack)	Use with HandiSwage Studs to achieve angled cable runs on stairs
C0307-U007-2	Deluxe Cover Nut Set (2 Pack)	Used to tension and "cap off" threaded end of HandiSwage Stud
C0308-UF07-2	Acorn Nut Set (2 Pack)	Used to tension and "cap off" threaded end of HandiSwage Stud
C0309-XX02-10*	HandiSwage Cover Nut Set (10 Pack)	Used to tension and "cap off" threaded end of HandiSwage Stud. Color options
<b>Cable Stabilizer Kits</b>		
S0950-0060	Stainless Cable Stabilizer Kit	Use on level sections where post spacing exceeds 4 feet (up to 7 feet)
S0950-S060	Stainless Cable Stabilizer Stair Kit	Use on stair sections where post spacing exceeds 4 feet (up to 7 feet)
A0908-XX60*	Aluminum Cable Stabilizer Kit	Use on level sections where post spacing exceeds 4 feet (up to 7 feet)
A0908-XX60-ST*	Aluminum Cable Stabilizer Stair Kit	Use on stair sections where post spacing exceeds 4 feet (up to 7 feet)
<b>Tools</b>		
C0988-1000	RailEasy Drill Template	Used to mark hole locations for cable and fittings. Spaced 3" on-center
C0989-00HD	RailEasy Cable Cutter	Cuts cable cleanly and easily
E0113-H600	HandiSwage Hand Swager	Crimps HandiSwage fittings onto cable. Includes After Swage Gauge
E0113-HG00	After Swage Gauge	Used to make sure "after swage" dimension of fitting is correct
C0731-TK01-2	HandiSwage Combination Wrench (2 Pack)	For installing HandiSwage and stainless cover nut sets
E0114-0000	Cable Grip Pad (3 Pack)	Used to protect cable from vice grips during tensioning process
E0113-CD04-2	HandiSwage Cutting Disk (2 Pack), 4-1/2"	Used to trim excess thread on HandiSwage Studs after tensioning of cable run

\* "XX" in the part number is the color designation. Replace with "BK" for Black, "MT" for Metallic, "BR" for Dark Brown, "LB" for Light Brown, "WH" for White or "BZ" for Bronze.